

The Practical use of LED Light Controllers within Machine Vision systems

The successful, cost-effective application of a Machine Vision system is often dependent on the interplay of many individual elements, including machine vision lighting. This Technical guide outlines the particular benefits of utilising LED Light Controllers within such systems, it describes the principle of this technology and illustrates its use within practical applications.

The guide uses the Gardasoft RT Series of controllers as the base for this overview, and concludes with selection criteria for this specific product range.

1.0 Why use an LED Light Controller ?

LED Light Controllers are an essential element of any vision system which needs to optimise illumination intensity and precision trigger sequencing between vision cameras and lights. The following are the main areas where you will benefit from the use of an LED light controller:

- **Pulse (or strobe) control**
Where you require to synchronise the ON time of your light with the camera and target product (available to nano-second timing resolution)
- **Overdriving**
Where you require increased intensity from your LED light for a short, defined, period of time (with up to 10x overdriving capability)
- **Continuous current power supply**
Where you require a highly stable constant current supply for LED lighting
- **Control of multi-lighting schemes**
For systems with multiple lighting configurations which require intensity control and high speed synchronisation (from single or multiple triggers)
- **Remote configuration changes**
For systems where it is advantageous to have remote setting of lighting system parameters – eg: to facilitate efficient set-up during system commissioning



LEDs are current driven devices

Whilst LED Lights are specified as either 12V or 24V lights, the actual LEDs are semiconductor devices whose light output is a direct result of the current through the device, not the voltage. All LED device manufacturers specify that current control is advised for efficient use.

Typically, LED datasheets will indicate that very small changes in LED voltage results in large changes in the LED current; and large changes in LED current results in large changes in light output intensity. Gardasoft LED controllers for example therefore regulate the current, not the voltage, so that light output is stable, tightly controlled and highly repeatable.

Durchlassstrom²⁾ Seite 17
Forward Current²⁾ page 17

$$I_F = f(V_F); T_A = 25\text{ }^{\circ}\text{C}$$

Courtesy of OSRAM

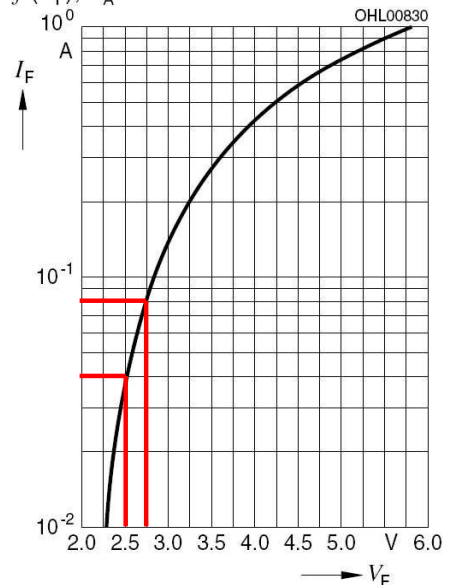

Controlling the current allows for precise control of the LED light output, additional benefit is then also available to users are looking to overdrive their lights to increase light output.

2.0 Advantages of Pulsing

Gardasoft Vision's controllers generally have two main modes of operation - Pulsed or Continuous.

Continuous mode

Continuous output is where the lighting is on all the time. This is the easiest mode to use as the intensity of the lighting is the only parameter that needs to be set. No overdriving is permitted.

Pulsed (or Strobe) mode

In pulsed mode the lighting is switched on only when required. The controller receives a trigger signal when a pulse is required. The delay from the trigger to the output pulse, the length of the pulse and the intensity of the pulse are all configurable.

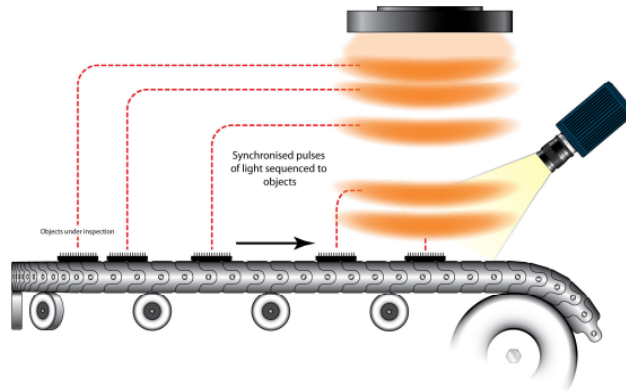

Using Pulsing, it is possible to freeze the image of moving objects. Gardasoft's controllers have fine adjustment of the pulse timing, which is often more flexible than the camera's timing. The camera can be set for a longer exposure time and the light pulsed on for a short time to freeze the motion.

Strobing or pulsing of the lighting can freeze fast moving action as shown below...

Below, glass bottles are inspected for defects on a high-speed production line using back-lighting and strobe illumination



3.0 Overdriving LEDs

At their specified current rating, LEDs and LED Lights output 100% brightness. However, it is possible to obtain more than 100% brightness by driving with more current rating for short pulses. This Overdriving, in conjunction with Gardasoft SafePower™ and SafeSense™ technology, enables users to do this with ease and complete confidence.

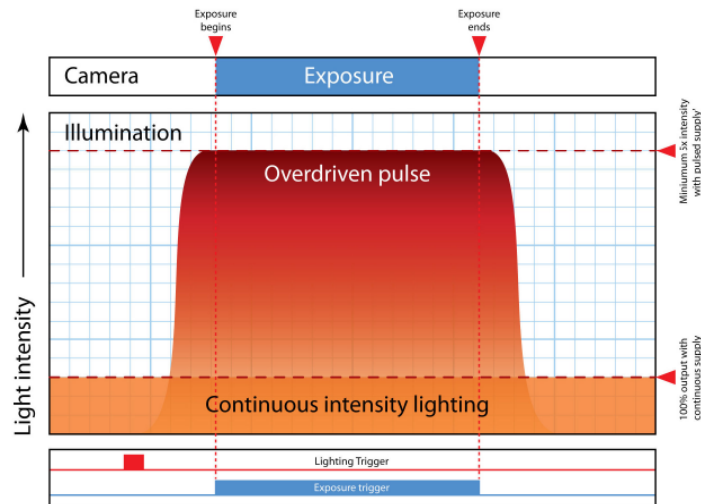

Overdriving is used with pulse lighting and it brings benefit to most Vision applications. The exceptions are applications where the camera is exposed for a high percentage of the time, for example Line Scan applications.

Converting a constant illumination system to pulse illumination is straightforward. The trigger for the camera is sent to a lighting controller. The controller provides precise pulse width timing, power and brightness control for the lighting pulse. This ensures that the lighting pulses during the camera exposure time and that the light energy is the same for every image.

3.1 Accurate overdriving of LED lights

For applications where the user wishes to overdrive LEDs, controlling the current is especially critical. To overdrive a light by a factor of 2, you double the current. To overdrive the light by a factor of 5, you increase the current by a factor of 5. But this level of accurate overdriving is not possible with a voltage based driver - increasing the voltage will not relate to a directly proportional increase in the current, so for example, some lights might need 28V for twice the level of brightness, others might need 40V.

3.2 Safe overdriving of LED Lights

Accurate overdriving is a major step forward in LED lighting control; equally it's important to ensure that too high a duty cycle is not selected. Gardasoft removes this potential with its patented SafeSense™ technology. When a light is connected, the Safesense™ technology runs a very rapid routine that determines the actual rating of the light. (See further details on SafeSense™ later in this document).

4.0 Triggering Controllers – available modes

This section deals with the different modes of triggering that are available with the Gardasoft RT-Series of LED Controllers. It also discusses the typical application of these trigger modes in terms of how the output of a light should synchronize with camera exposure time.

4.1 Continuous mode

Provides a constant current output without the need for a trigger signal

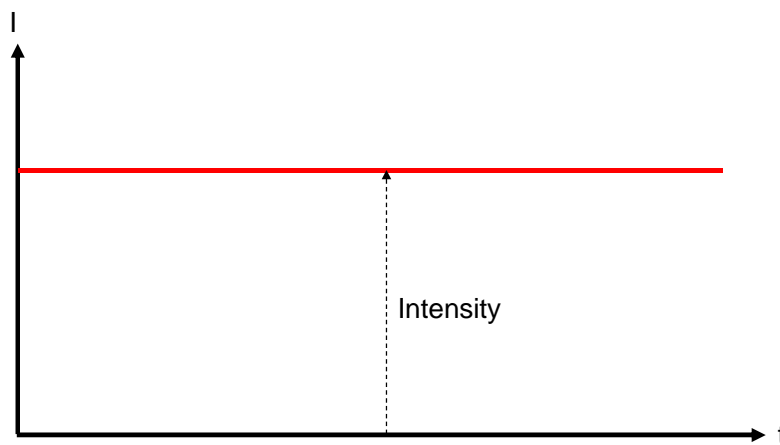

4.2 Pulsed mode

Provides a single pulse when a trigger pulse is received:

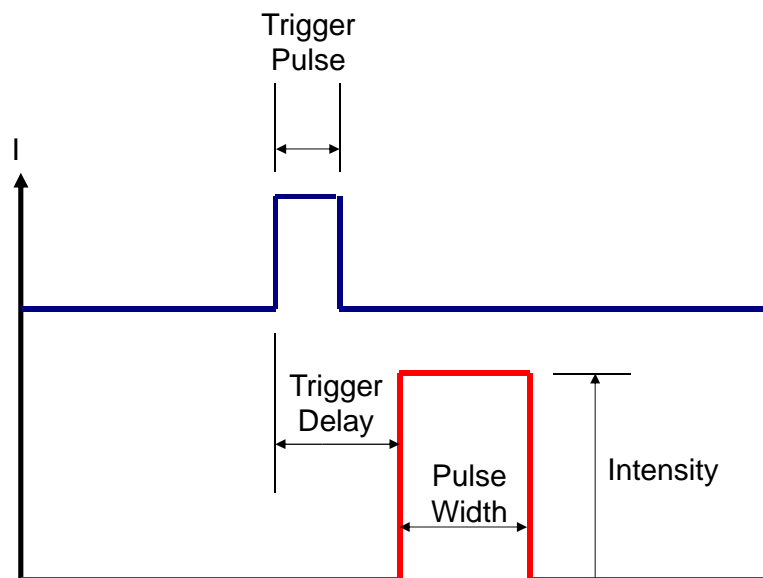

4.3 Switched mode

Provides output current whilst the trigger signal is live:

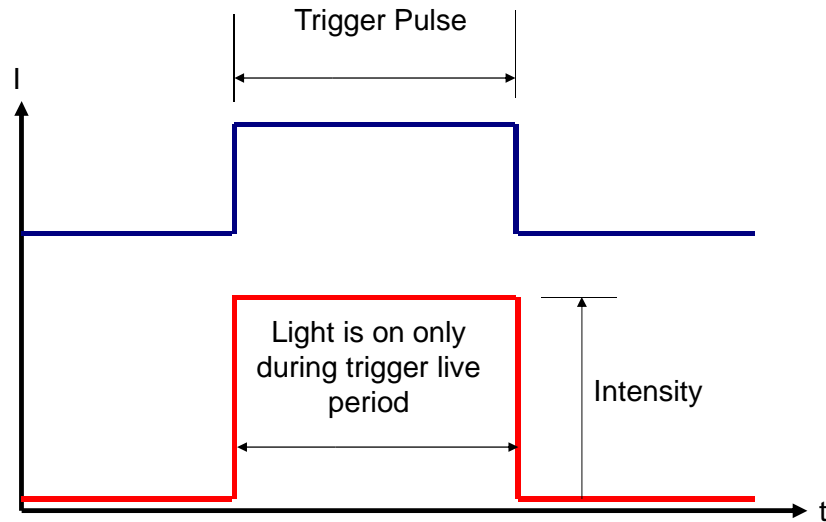

4.4 Options for Triggering topologies

The diagram below illustrates some typical camera triggering topologies. Looking from left to right, topology 1 shows the traditional triggering arrangement whereby the camera is triggered by a sensor at the infeed of the manufacturing sub-process; the camera then triggers the lighting controller and starts its exposure. Topology 2 shows the light controller being triggered by the sensor, the lighting controller then triggers the camera. This has the advantage that the lighting controller can filter the trigger signal before passing the command to the light. Topology 3 shows an increasingly popular arrangement where the camera is continuously taking images and the camera's on-board software looks for relevant products in view. There is no external trigger and the lighting controller provides a regular trigger to the camera. Alternatively, the camera continually triggers the lighting controller.

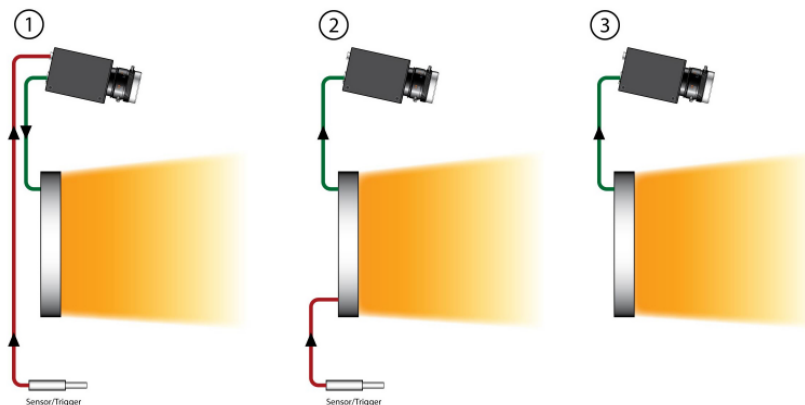

5.0 What is SafeSense™?

The patented SafeSense technology from Gardasoft allows the safe and accurate driving of LED lighting for machine vision applications; this technology enables the performance of LED lighting to be fully optimized whilst ensuring that the lighting can never be overdriven outside of permissible current ratings. Overdriving the LEDs allows for more light output to be achieved and SafeSense imposes safe working limits based on the pulse width and duty cycle for overdriving, thus providing full protection. In constant mode, the maximum output current allowed would be the maximum rating defined by SafeSense.

SafeSense works by using the following techniques:

- Sensing when a light is connected
- Finding the current rating of the light
- Driving the light within safe limits
- Detecting faults

Sensing when a light is connected

The operation of the controller is as follows:

- Tries to drive a low current pulse through the light
- Measures the current to see if a light is connected
- If 10 pulses are successful, detection is complete

Finding the current rating of a light

Current rated lights

The current rating is entered by the user. This can be done using the front panel, webpages, configuration program or application program

Voltage rated lights

If the voltage rating of a light is known, this is simply entered into the configurator and the current rating can be automatically measured. In some configurations, the voltage rating can be determined by the type of connector on the light (12-36V), and the current again will be automatically calculated

5.3 SafeSense™ – vital when overdriving

Driving the light within safe limits. The controller will limit the parameters based on the limits in the table below. Customer specified limits can be installed into the controllers at the factory.

Overdriving	Allowed pulse width	Allowed Duty Cycle
Up to 100%	1S	100%
Up to 200%	30mS	15%
Up to 300%	10mS	10%
Up to 500%	2mS	5%
Up to 1000%	1mS	2%

5.4 Detecting faults

The current and voltage to the light is continuously monitored; the faults detected are:

- Open circuit** - The light is disconnected
- Short circuit** - The light has a wiring fault
- Voltage high** - An LED or wiring failure in the light
- Current low** - Too much voltage is required to drive the requested current

6.0 What is SafePower™ ?

Gardasoft's RT LED Lighting Controllers have SafePower™ technology. The advantages of SafePower are:

- Heat dissipation in the controller is very low
- The load voltage can be higher than the supply voltage
- The choice of supply voltage is more flexible
- High continuous currents can be output without heatsinking the controller

SafePower works for all operating modes (continuous, pulsed, switched and selected) automatically without the user needing to configure it.

The Gardasoft RT series have SafePower as standard. This adjusts the supply voltage to make most efficient use of the power. The RT controllers still have analogue regulation of the constant current to the lighting, to give very stable output.

SafePower works at around 80% to 95% efficiency at high power.

7.0 Advanced and Custom controller functions

Gardasoft produce custom controller features for some customers. Some of these are very specific and others are more generally useful.

7.1 Different Pulse intensities for individual channels

An example of this customization is the “S15” special feature which is now available on several controllers. This firmware feature outputs a series of pulses of different intensities on different channels on each trigger. When the sequence finishes it restarts from the beginning. The length of the sequence, the different intensities and the pulse width on each channel is configurable.

One input is used to trigger the light pulses and another can be used to reset the sequence to ensure that the system starts in a synchronized state. An Ethernet command can also be used to reset the sequence.

An example of a system that might use this could be a machine that measures dimensions, checks for surface defects and impurities in disc shaped products.

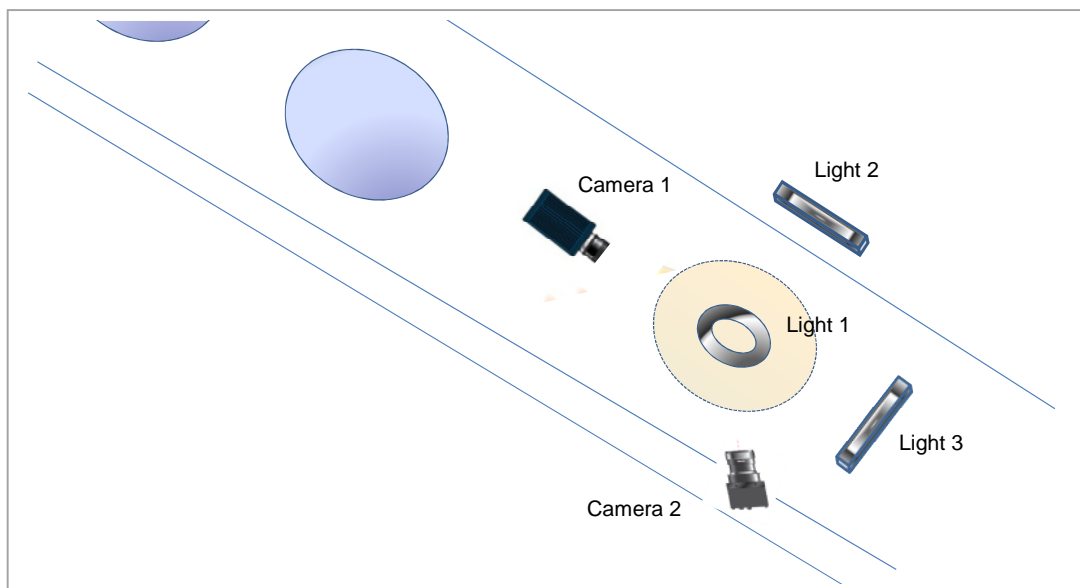

Light 1	on-axis top light
Light 2	dark field top ring-light
Light 3	dark field bottom ring-light

These lights are used to take four images of a component:

- | | |
|---------|---|
| Image 1 | lights 1, 2 and 3 on to measure dimensions, camera 1 triggered |
| Image 2 | light 2 on half power to detect surface defects, camera 1 triggered |
| Image 3 | light 1 on low power to detect impurities, camera 1 triggered |
| Image 4 | light 3 on half power to detect features underneath, camera 2 triggered |

This works as in this diagram. The lighting controller is triggered once for each image to be taken. On each trigger a different combination of lights is pulsed to take four images with different lighting schemes. When the next part arrives the sequence repeats.

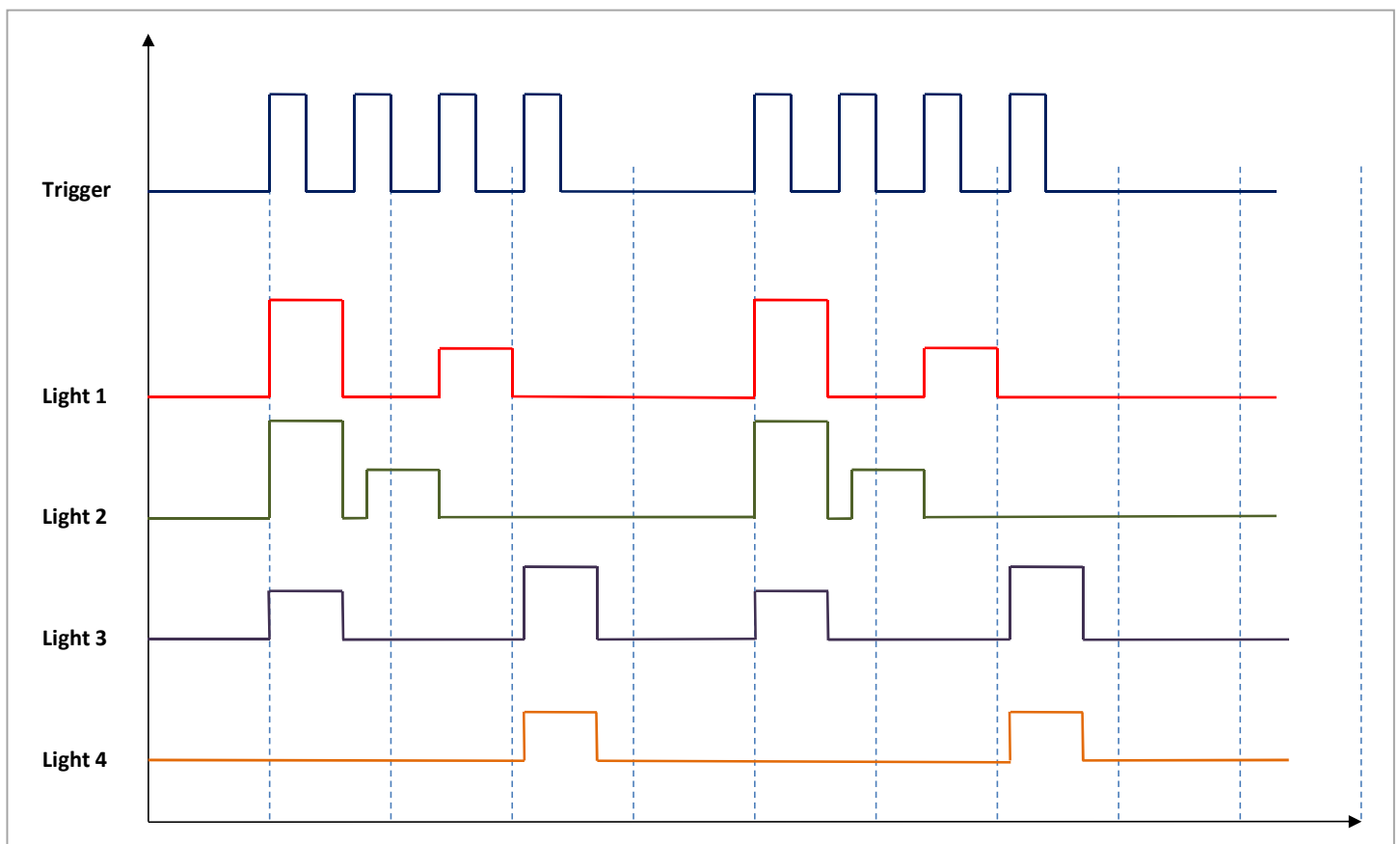

Gardasoft's CC320 trigger timing controller could be used to generate triggers for the cameras and lighting controller and integrate other signals such as part sensor, conveyor belt encoder and reject gate.

The S15 feature could also be used to pulse red, green and blue lights in sequence to build up a colour picture from three monochrome images.

8.0 Why use Gardasoft LED Light Controllers?

8.1 Fast pulsing for high speed applications

The Gardasoft range of controllers all offer high speed pulsing for rapid strobing of the LED lights. Fast Pulse versions of the RT Series and PP Series have a minimum pulse width of 1µS.







Throughput and UPH (units per hour) are the key factors for any machine vision application. With today's high speed cameras and data acquisition technology it is vital that the illumination meets these high speed demands.

The Gardasoft LED lighting controllers offers very fast pulsing throughout the range ensuring that the illumination does not become the limiting factor when throughput is vital.

8.2 High Power for the latest generation LED technology

LED technology and materials science has developed enormously over the years. The latest high brightness and high intensity LEDs are now capable of solving applications where previously they could not compete with incandescent or other lighting technologies. Today's high power LEDs are really pushing the boundaries forward. These high power LEDs require high power controllers. The Gardasoft range meets this ever increasing demand.

The Gardasoft controllers have options of strobing up to 20A on each channel; offering an LED lighting controller that can really take advantage of these new LED technologies.

-  **LEDs are current driven devices, Gardasoft controllers are current controllers**
-  **Precise control when overdriving LED lights offering extra light brightness**
-  **SafeSense™ offers safe, reliable overdriving techniques**
-  **Extremely fast pulsing / strobing for high speed applications**
-  **High power controllers for the latest high brightness LED technologies**
-  **A range of interface options (Push-button, RS232, Ethernet)**

8.3 Three ways to configure

All Gardasoft RT Series controllers have options to be configured via RS232 or Ethernet, and the RT200 Series has the additional option for front panel push-button operation. With the Ethernet options, a Web browser can be used to access the RT Series internal Web pages allowing status to be viewed and parameters to be changed.

The RT Series can also be configured using simple string commands sent from an application program using RS232, TCP/IP or UDP. The Gardasoft Vision Website 'www.gardasoft.com' has a free download of a demonstration program (with fully commented source) showing how the RT Series Controllers can be controlled from a PC using C++. The configuration is stored in non-volatile memory providing turn-key operation.

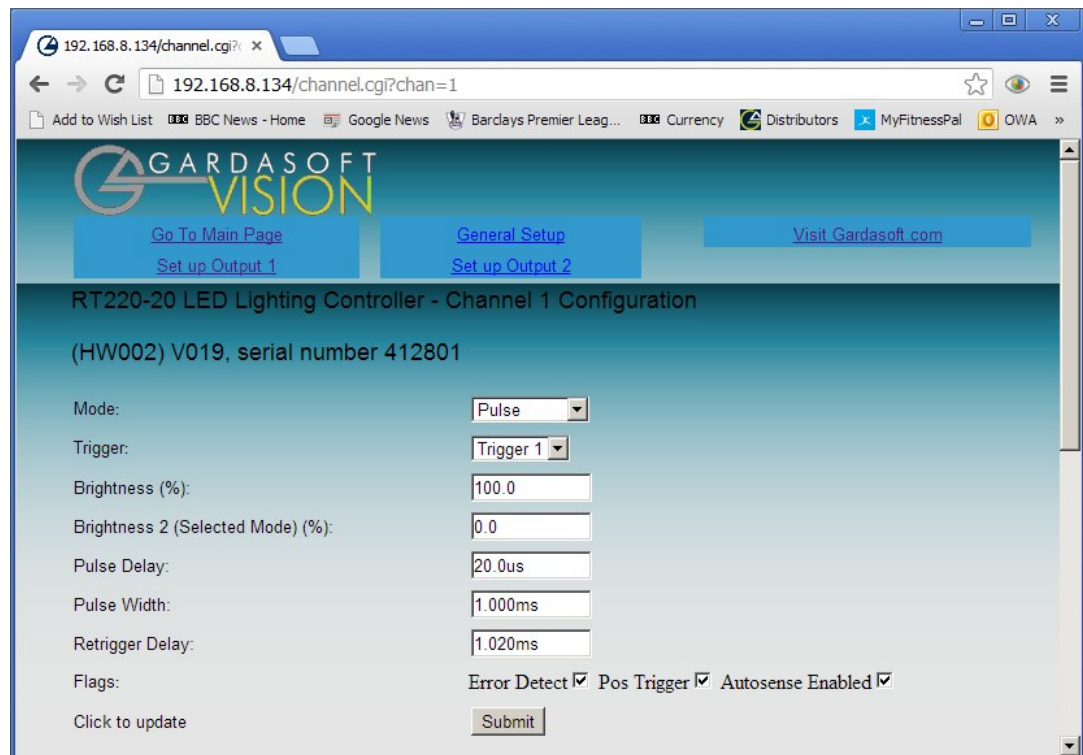

Gardasoft Product Selection Guide

CONTROLLER	NUMBER OF CHANNELS	MAXIMUM CURRENT RATING			TIMING	LED SAFETY	EASY INTEGRATION	INTERFACING		
		Continuous	Pulsed	Resolution	Minimum Pulse Width	SafeSense™	SafePower™	P-Button	Ethernet	RS232
RT Series Controllers (advanced function)										
RT200-20	2	3A	20A	5mA	20µS	•	•	•		
RT200F-20	2	3A	20A	5mA	1µS	•	•	•		
RT220-20	2	3A	20A	5mA	20µS	•	•		•	
RT220F-20	2	3A	20A	5mA	1µS	•	•		•	
RT260-20	2	3A	20A	5mA	20µS	•	•			•
RT260F-20	2	3A	20A	5mA	1µS	•	•			•
RT420-20	4	3A	20A	5mA	20µS	•	•		•	
RT420F-20	4	3A	20A	5mA	1µS	•	•		•	
RT460-20	4	3A	20A	5mA	20µS	•	•			•
RT460F-20	4	3A	20A	5mA	1µS	•	•			•
RT820F-2	8	3A	2A	1.0mA	1µS	•	•		•	
RT820F-20	8	3A	20A	5mA	1µS	•	•		•	
RT860F-2	8	3A	2A	1.0mA	1µS	•	•			•
RT860F-20	8	3A	20A	5mA	1µS	•	•			•
RC Series Controllers (entry level)										
RC-100	1	1A	1A	1.5mA	100µS	•	•	•		
RC-120	1	1.2A	2A	1.5mA	100µS	•	•	•	•	
PP Series Controllers (standard function)										
PP500	2	2A	10A	2.5mA	20µS	•		•		
PP500F	2	2A	10A	2.5mA	1µS	•		•		
PP520	2	2A	10A	2.5mA	20µS	•		•	•	
PP520F	2	2A	10A	2.5mA	1µS	•		•	•	
PP600	2	4A	10A	0.25mA / 2.5mA	20µS			•		
PP600F	2	4A	10A	0.25mA / 2.5mA	5µS			•		
PP610	2	4A	10A	0.25mA / 2.5mA	20µS			•		•
PP610F	2	4A	10A	0.25mA / 2.5mA	5µS			•		•
PP420	4	2A	10A	2.5mA	20µS	•			•	
PP420F	4	2A	10A	2.5mA	1µS	•			•	
PP820	8	2A	20A	100mA	1µS				•	
PP821	8	2A	2A	10mA	1µS				•	
PP822	8	2A	5A	25mA	1µS				•	
PP820C	8	2A	20A	5mA	1µS				•	
PP821C	8	2A	2A	0.5mA	1µS				•	
PP822C	8	2A	5A	1.5mA	1µS				•	
PP860	8	2A	20A	100mA	1µS					•
PP861	8	2A	2A	10mA	1µS					•
PP862	8	2A	5A	25mA	1µS					•
PP860C	8	2A	20A	5mA	1µS					•
PP861C	8	2A	2A	0.5mA	1µS					•
PP862C	8	2A	5A	1.5mA	1µS					•
PP1620	16	2A	20A	6mA	1µS				•	
PP1621	16	2A	2A	1mA	1µS				•	
PP1660	16	2A	20A	6mA	1µS					•
PP1661	16	2A	2A	1mA	1µS					•
PPCC1620	16 + 8 trigger o/ps	2A	20A	6mA	1µS				•	
PPCC1621	16 + 8 trigger o/ps	2A	2A	1mA	1µS				•	
PPCC1660	16 + 8 trigger o/ps	2A	20A	6mA	1µS					•
PPCC1661	16 + 8 trigger o/ps	2A	2A	1mA	1µS					•

© Gardasoft Vision Limited. 2013

About Gardasoft

Gardasoft are a world leader in the design and manufacture of LED illumination and control solutions for Machine Vision and Intelligent Traffic applications, based in Cambridge, UK. Their RT and PP Series LED Pulse Controllers lead the field in LED Lighting Control, and their VLX Series Line Lights and VTR Series ANPR Strobes are the industry's highest intensity LED Illuminators