

Anti-Shading Lens

Apo-Xenoplan 2.0/24-0005

These high-resolution, high-speed lenses are optimized for the use of 4 and 8 megapixel 1.3" sensors with micro-lenses on the sensor surface. The special optical design prevents unwanted shading on the sensor. This makes it much easier to combine a homogeneous luminance distribution with high imaging performance. The image circles are very large for C-Mount lenses. With a 1.3" sensor, the relatively short focal lengths allow a large coverage range at a short working distance. The lenses are also broadband coated and can be used in the visible range 400 – 700 nm or the near infrared range 700 – 1000 nm.



Apo-Xenoplan 2.0/24

Key Features

- Anti-shading for sensor sizes up to 1.3"(image circle 24 mm)
- Designed for 4 and 8 Mpix sensors with micro-lenses
- High resolution optics 400 - 700 nm (VIS) / 700 - 1000 nm (NIR)
- Very high MTF across the entire sensor
- Robust mechanics for industrial environment
- Compact and low weight
- Focus and iris setting lockable

Applications

- Machine Vision and other imaging applications
- 3D measurement
- Traffic
- Etc.

Technical Specifications

F-number	2.0
Focal length	24.5 mm
Image circle	24 mm
Transmission	400 - 1000 nm
Interface	C-Mount
Weight	80 gr.
Filter thread	M37 x 0.75
Code no.	1071371

Contact

Jos. Schneider Optische Werke GmbH
 Ringstraße 132
 55543 Bad Kreuznach
 Germany
 Phone +49 671 601-205
 Fax +49 671 601-286
www.schneiderkreuznach.com
industrie@schneiderkreuznach.com

Schneider Optical Technologies Co., Ltd.
 Rm. A505 Yingdali Science Park, Hongmian Rd.,
 Futian Free Trade Zone, Shenzhen 518038,
 P.R. China
 Phone: +86 755 88 32 11 70
 Fax: +86 755 88 32 11 75
www.schneiderkreuznach.com
info@schneider-asiapacific.com

Schneider Optics Inc.
 285 Oser Ave.
 Hauppauge, NY 11788
 USA
 Phone +1 631 761-5000
 Fax +1 631 761-5090
www.schneideroptics.com/industrial
industrial@schneideroptics.com

Apo-Xenoplan 2.0/24

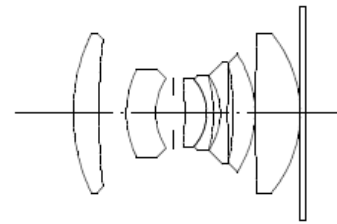
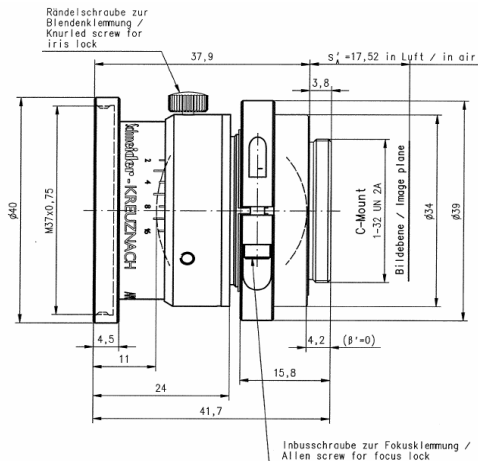

APO-XENOPLAN 2/24

f' = 24.5 mm	β'_p = 1.937
s_F = 0.9 mm	s_{EP} = 13.5 mm
s_{F^*} = 17.3 mm	s_{AP^*} = -30.1 mm
HH' = -5.5 mm	Σd = 27.0 mm

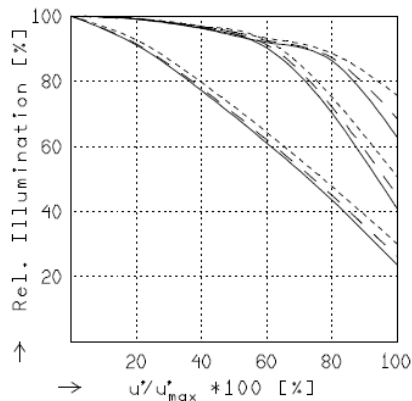

RELATIVE ILLUMINATION

The relative illumination is shown for the given focal distances or magnifications.

	$f / 2.1$	$f / 2.8$	$f / 4.0$
— $\beta^* = -0.0200$	$u_{max}^* = 11.7$	$00^* = 1269.$	
- - $\beta^* = -0.0500$	$u_{max}^* = 11.7$	$00^* = 535.$	
---- $\beta^* = -0.1000$	$u_{max}^* = 11.6$	$00^* = 291.$	

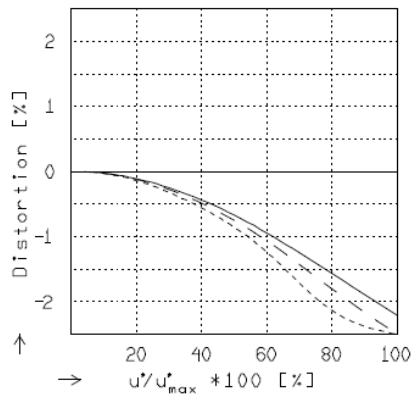

DISTORTION

Distortion is shown for the given focal distances or magnifications. Positive values indicate pincushion distortion and negative values barrel distortion.

— $\beta^* = -0.0200$	$u_{max}^* = 11.6$	$00^* = 1269.$
- - $\beta^* = -0.0500$	$u_{max}^* = 11.6$	$00^* = 535.$
---- $\beta^* = -0.1000$	$u_{max}^* = 11.6$	$00^* = 291.$

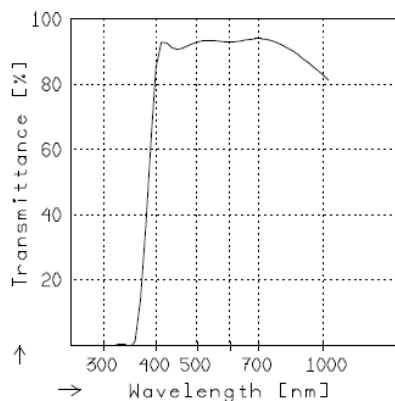

TRANSMITTANCE

Relative spectral transmittance is shown with reference to wavelength.

Apo-Xenoplan 2.0/24

APO-XENOPLAN 2/24

MODULATION with reference to the relative image height

Wavelength λ	[nm]	555	655	605	505	455	405
Spectral weighting	[%]	19.6	23.7	22.2	15.7	12.1	6.7
Spatial frequency R	[1/mm]	25	50	75			
Image- \emptyset f / 2.1	[mm]	24.0					
Image- \emptyset f / 4.0	[mm]	24.0					

radial —
tangential - -

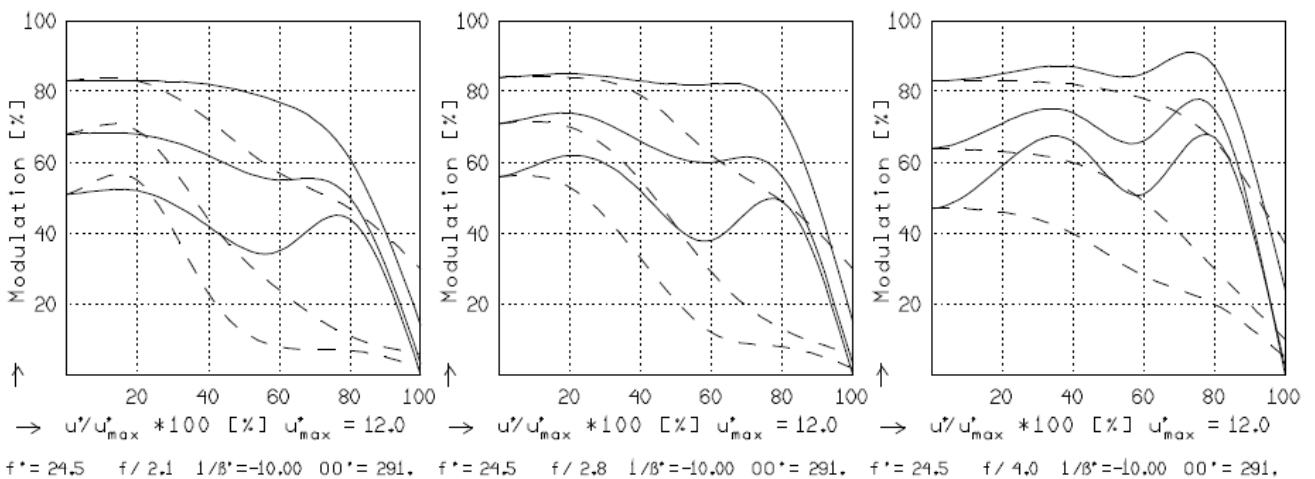
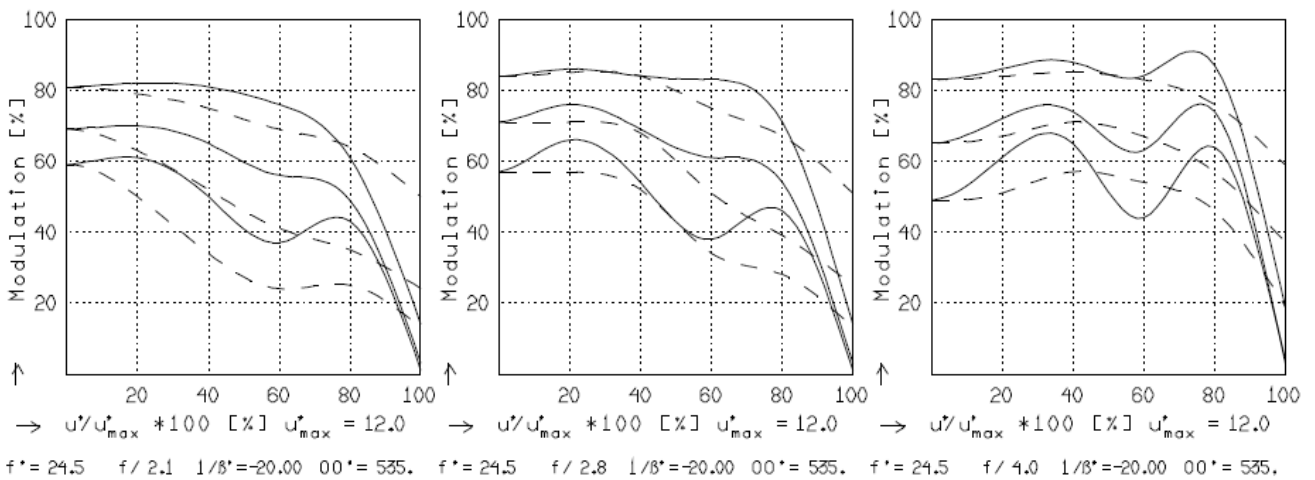
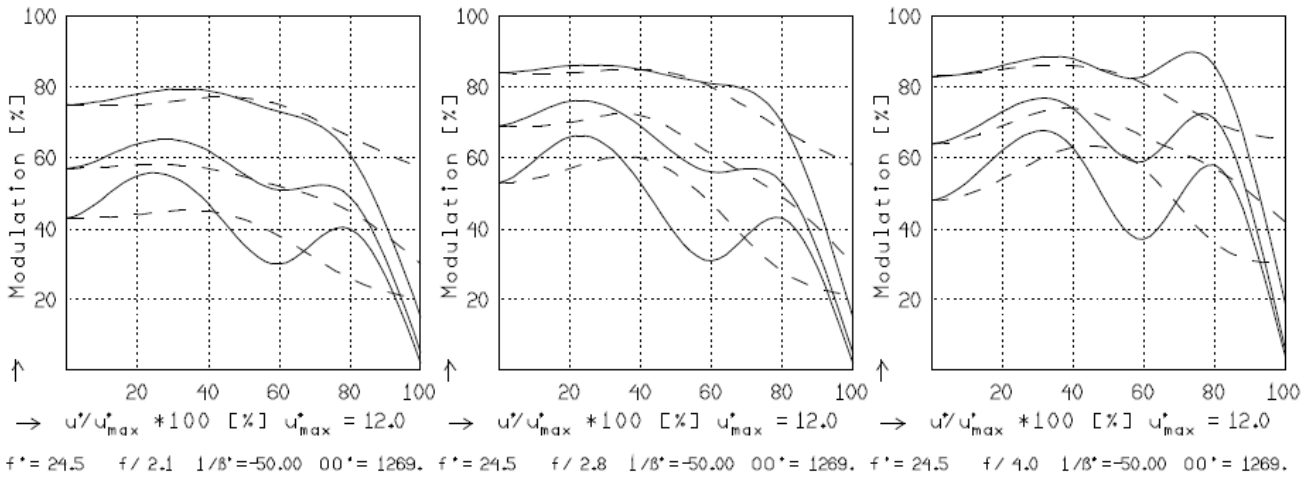

Focusing : MTF_{max} at f / 2.0 , R = 75 1/mm, $u^*/u_{max}^* = 0$